



<https://www.wdmusic.co.uk/>

**To start with.....**

One of the issues with buying an 'off the shelf' guitar is that it can be so impersonal unless you actually fell in love with it in the shop window. Many customer either don't have the time or the skills to do their own 'kit-guitar' and so I often get asked to make a 'Peter Allen - Custom Shop' guitar. The customer is restricted to a degree on what is out there (in shapes/style) to purchase but it does allow them the satisfaction of knowing that nobody else is going to have his/her chosen, unique guitar. The final cherry on the cake is going to be the Professional Setup to make it play at its best.

This customer brought me a generic Stratocaster neck and body made by different companies, so now let the storyboard unfold.....



**Parts for Assembly**

## Parts for Assembly

Here are the parts ready for the day when we can assemble the guitar.

Both the neck and body need to be prepared (degreased & sanded) before I can apply a finish. They may look OK from the factory but they could have marks missed by the final sanding and may have collected scratches along the way in packing or inspection, not to mention oil/grease from sweaty hands! Yes - I know the screws and wire etc. are missing, doesn't look so nice with them in.



## Making the neck fit

Making a neck and body fit together is taken as a given by the amateur but when you have committed yourself to the purchase it's common to find that they don't align or go together! In this case they wouldn't assemble at all which was better because they can be made to fit. A sloppy joint is still going to look sloppy when it's finished so we are off to a good start.



## Marking out

First, with the neck sat on the neck socket, masking tape is applied to protect the body. Pencil lines are marked on the body tape, taken from extended lines via a straight edge. The centre line is marked and we can see where the neck should line up.



## **Neck fitted**

The neck will now need some extra lacquer and so a small amount of slack is added for when we will be putting the neck on later, Trying to ease it at final assembly may chip and spoil it.



## **Checking the frets - Ahhh!.**

Just as I think things are going well, I find that this neck is a disaster! As you can see from the picture above, the fret ends are proud (sticking up). No amount of tapping them down is going to help as the frets are loose in their slots. If the neck had an ebony or rosewood fingerboard, I would have glued the frets down. As it is, the neck came with only 'fumes' from the lacquer process and really needs a good protective coating. I guess this is where the factory cost saving was made! Best thing to do is remove the frets, de-nib it, lacquer it and then properly fit the frets. Sometimes what seems the long way round is actually the shortest route!

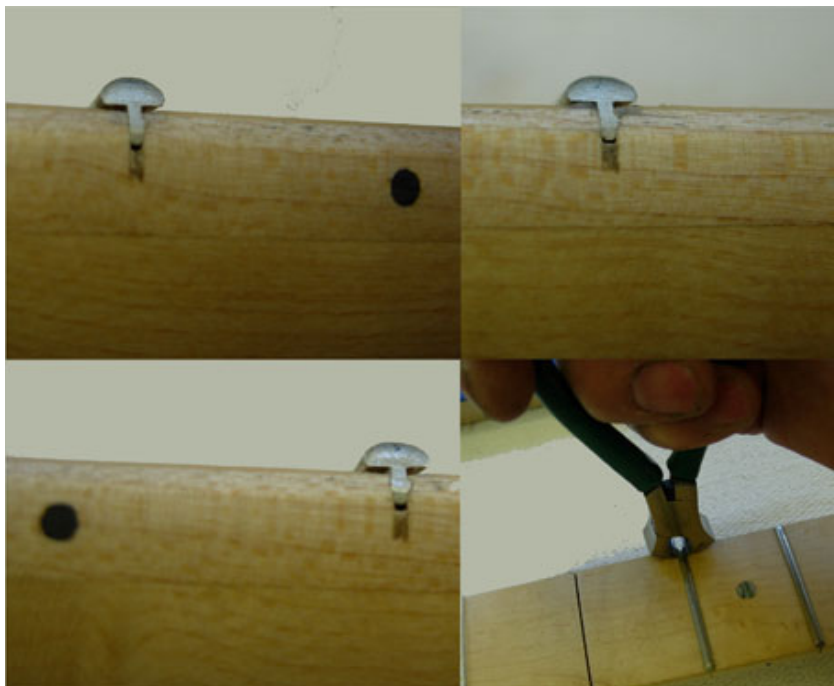

## Defretted

Having taken out the frets, it is important to prepare the wood for the lacquer. The secret of a good finish is in the preparation - just like building a house on good foundations. Now the frets are out, it actually allows me to check for lumps and dips in the fingerboard. This means that the fret dressing process will be easier to do at the final set-up. You guessed it - all along the inlay dots I find high spots. This is a common area for over or under-sanding.

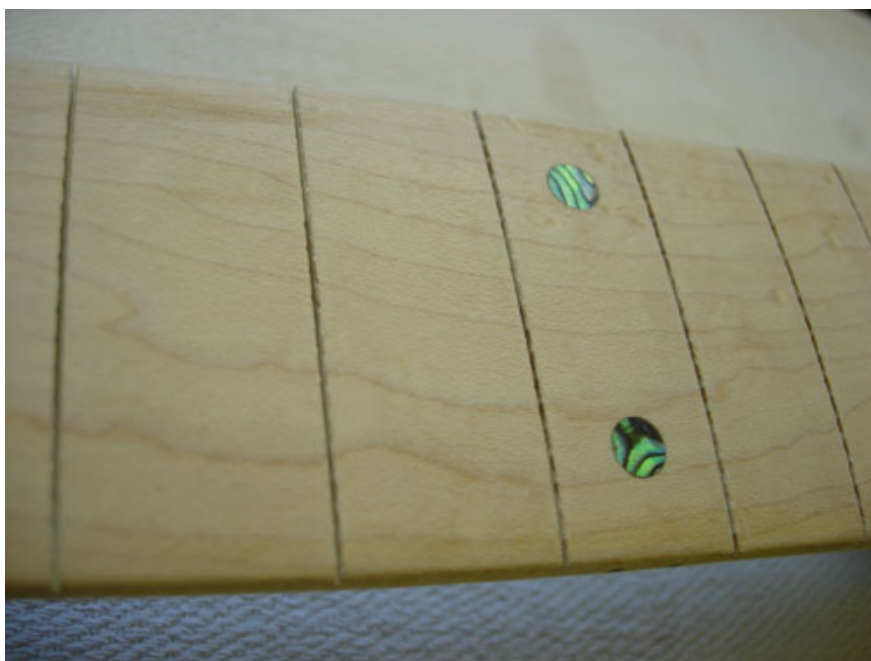

## Prepared for lacquer

Finally, having taken a detour, I can now put a coat or two of lacquer on the neck. One advantage of this has been to actually round-over the sharp machined edges of the headstock profile. The reason for this is that the surface tension of lacquer doesn't like corners and therefore runs away from it, leaving it thinner in these areas - one reason some of the cheaper Stratocaster necks have the lacquer wear away at the edges of the fingerboard. This neck had a nice soft edge but every other edge was too sharp for my liking.

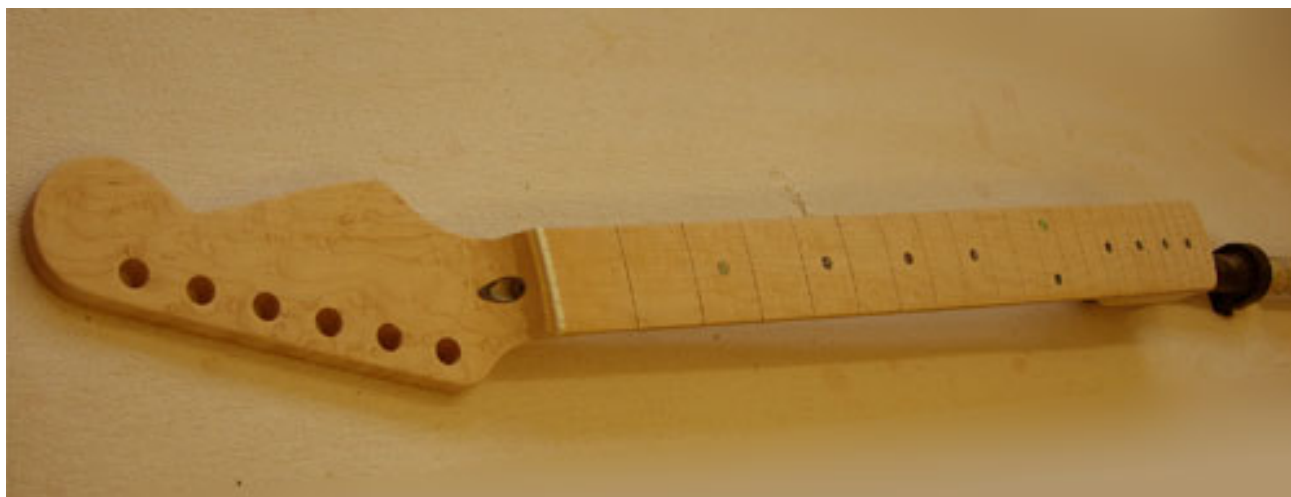

## Body Colour - Hmm.....?

The customer wanted a 'washed' colour of blue, and indicated to me the type of blue he had in mind. The reason for the wash colour is so that the grain can still be seen. I must say that the blue is a fabulous colour but the degree to which the colour is required is going to be difficult. I have knocked up some swatches of colour on an ash body slither and I now have some idea of what the sprayer had to deal with when doing a see-through 'butterscotch' Telecaster colour. I also know why it seems to be different on every batch and model made! In this instance you are privileged to see the sample colour before my customer visits. (Bear in mind that colours may not appear quite the same on the 'web' compared to 'in the flesh')

Now, all I need is the 'Go-Ahead' from the customer.



## Thumbs up & Sealer Coat Applied

The customer gave his approval to the colour and could see the problem of the blue on a yellow wood (trying to turn it green!). The first stage is to seal the wood and build up base coats so the blue tint could be applied.



## **Mask the Front & Back**

The front and back are masked off to prevent overspray. The edges are sprayed to give a deeper colour - it's to trick the eye into seeing more blue than I intend to apply to the front and back yet still see the grain through it.



## **Front & Rear Wash Colour Applied**

What is not seen here is the flattening off between layers of clear lacquer. This is to reduce the amount of sinkage into the grain. When a reasonably flat surface has been produced, the tint can be applied. The edges are blended in without creating too much of a big 'burst' effect - after all, the customer wants to see the wood.



## Sealing in the colour

Now that the wash-colour is applied, several layers of pull-over coats are applied. Its tricky getting the first coats even. It's important because the last thing we want to happen is a 'rub-through' when de-nibbing the surface in order to apply more lacquer!



## First top coats of lacquer applied

Now that more coats of lacquer are applied, it's still obvious that the Swamp Ash body is showing lots of lacquer sinkage into the grain. This is typical of the ash wood grain and the application of cellulose lacquer.



## **The lacquer builds**

The lacquer builds - several more coats are applied and then its time to say enough is enough. Too much lacquer can mask/dampen the sound.



## **Sanding the lacquer Flat**

Its time to sand the top flat, now that there are several coats sealing the wash-colour. That is, as flat as we can - bearing in mind the sinkage into the grain - it is always possible to rub-through the colour!





### **De-masking the neck socket**

Demasking the neck socket is done before polishing because the paint chips are sharp and can ruin the finish. Careful sanding back allows the neck to fit without pressure/stress on the lacquer edge.



### **Cut & Polish - finished?**

Finally - the lacquer can be cut (flattened) and polished. Whilst I am allowing a small amount of 'sinkage' as natural, I am on the lookout for over-spray and dull areas. The guitar will have a final polish at the very end of the build process.

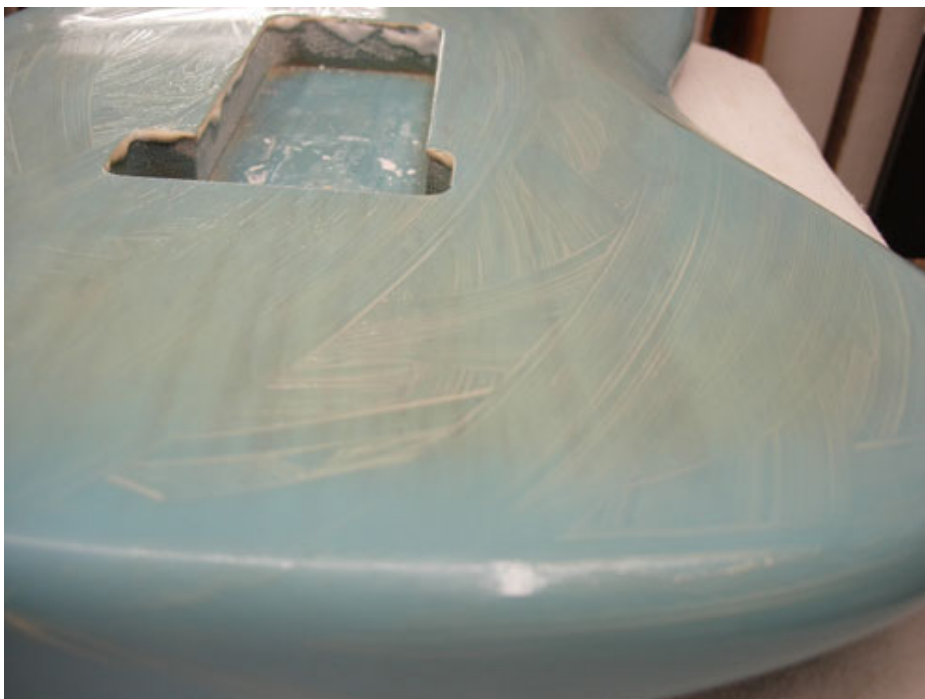

## Counter sink holes?

When the guitar's components are put on the body all the holes are counter-sunk. This helps prevent chipped lacquer or pulling the lacquer up as the screw goes in. You would be surprised at how many top class guitars are assembled without counter sinking screw holes.

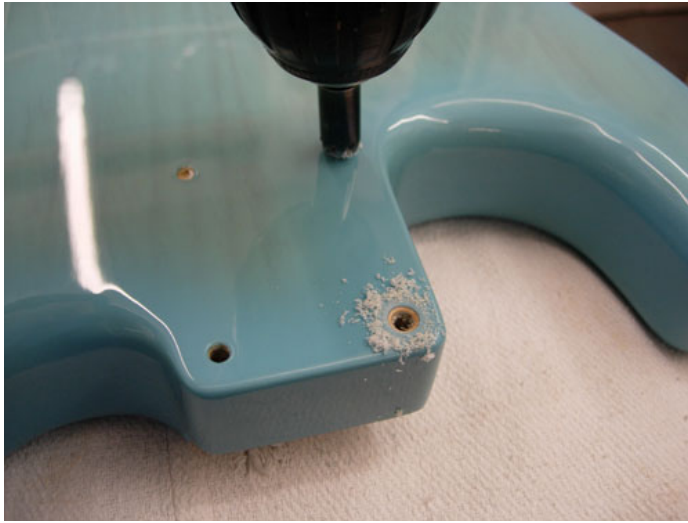

## Now back to the neck socket

Back in the neck socket, some of the natural wood has now been exposed after demasking. One trick is to tint the wood with the same colour paint and this restores the colour. After this touch-up has dried, wax (as in candle wax or tallow) is applied to the neck socket area. This aids assembly and prevents the lacquers sticking together.



## Fret dress after lacquering

Out of camera shot, you remember the neck has been through a similar lacquer process and refretted. It takes about a week for the lacquer to be hard enough to mask up without problems. This has to be done to protect the maple fingerboard. The lacquer is literally removed from all the frets. This is a time consuming operation and I haven't dressed the frets yet! Finally the frets are exposed and the fret dressing is completed.

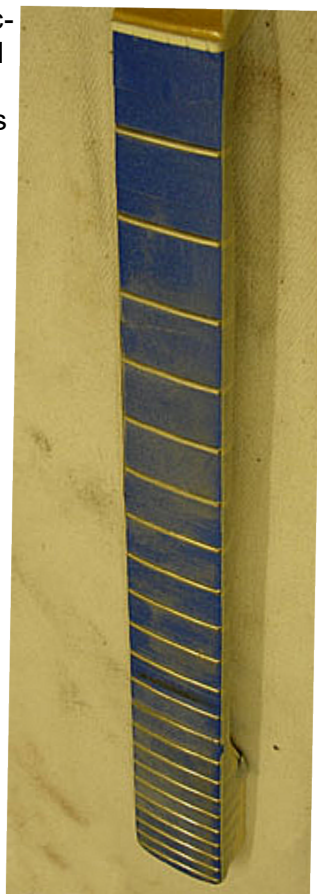

## Decal Applied

Many people apply fake decals to the headstock almost because they are embarrassed about it not being a Fender. For my customers that undergo this type of work, I offer the option of my own logo. After all, it would look naked without!



## Drill holes in the neck

The location of where to drill has been found by fitting the neck and pushing through the neck bolts. The pilot holes are then drilled in the neck, ensuring the correct depth-stop is set on the pillar drill. It's important to make sure the neck bolts (screws) are not too long - if they are there is a chance they will go through the front of the neck!!

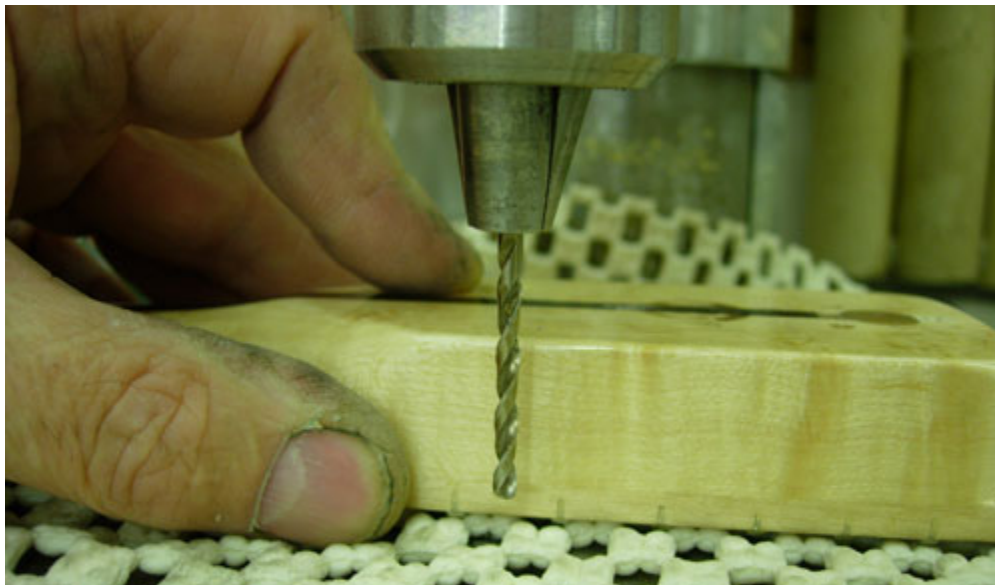

## Problems - Machine-heads

Unexpected problems can arise whether you're a luthier or novice, and when I opened the box of machine-heads I found that they were for right-handed (six-a-side).

No, I didn't fit them! It's possible that other people might have fitted them and seemingly 'got away with it' but the problem is the units would try to pull apart, causing problems in the future. Basically, they are designed so the pull of the string forces the components together - i.e. pushes the gear wheel onto the worm drive!

So I now have to order the correct parts. In the meantime the surplus lacquer in the hole is reamed away to allow a good fit.

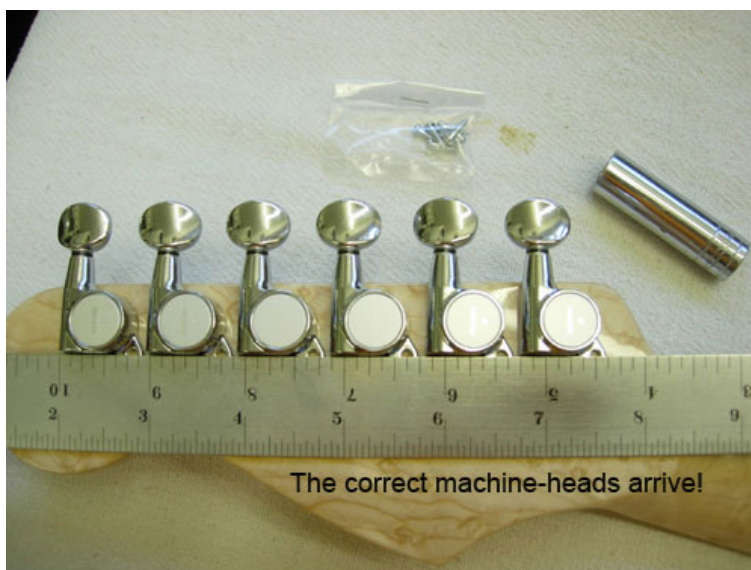

## Scratch-plate Problem

Now I find another problem - and another issue where a novice might make a botch of things. We are not ready to fit the scratch-plate yet but I do need to see how the pick-up pole pieces will align with the strings when I get them on. Note that, during machining, the operation for slotting the 5-way switch into the scratch-plate has been missed! Rather than send it back. I jig up the router and slot it myself!



## Coming together nicely....



More to follow this week as the completion date nears.....

## Scratch-plate - loaded.

The scratch-plate is fitted with a foil screen around the pickup area and controls. The components are loaded along with the pickups. The other half of the screening will be done later in the control cavities.

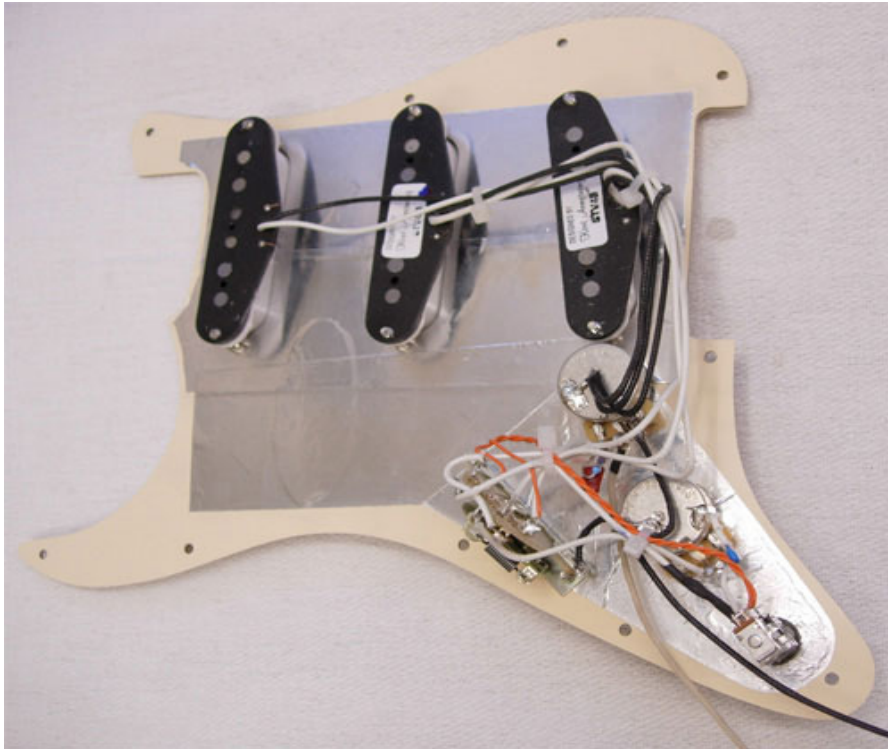

## Scratch-plate and Components.

The pickups were loaded onto the scratch-plate to see how things looked. At this point just before the tremolo posts go in, the scratch-plate needs to be able to move a little from side to side to allow for pickup (pole) alignment with the strings.

I should not be surprised to find that some wood needs to be taken out to get the scratch-plate to fit.

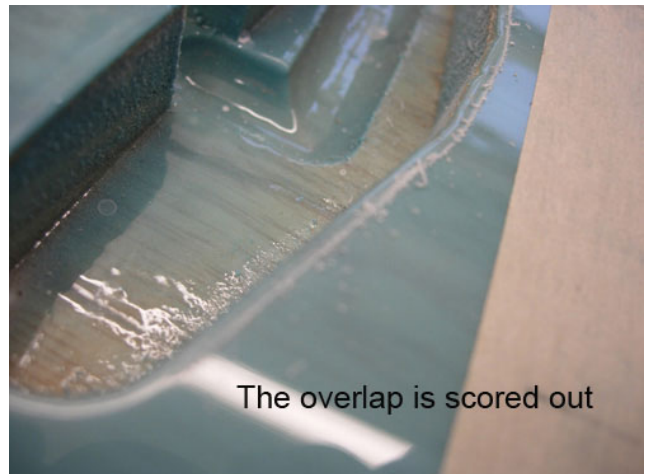

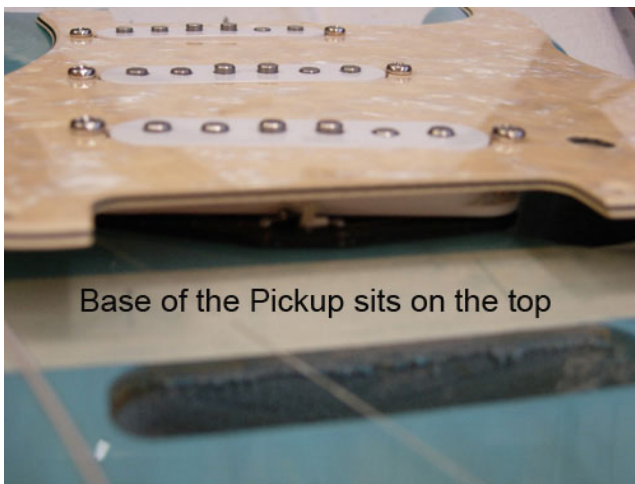

Base of the Pickup sits on the top



Added space is allowed for the pickup.

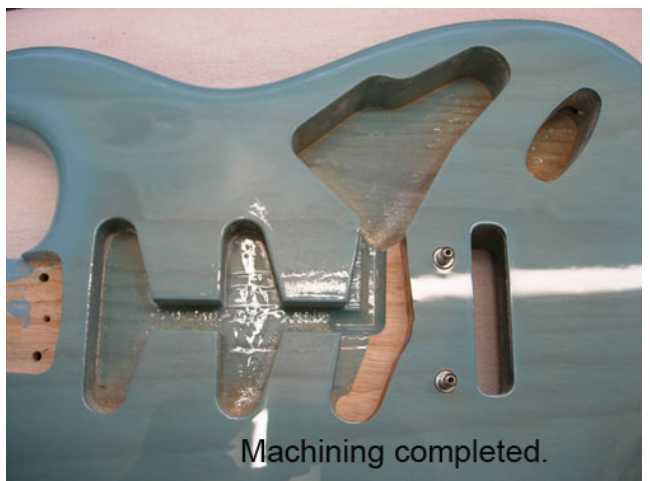
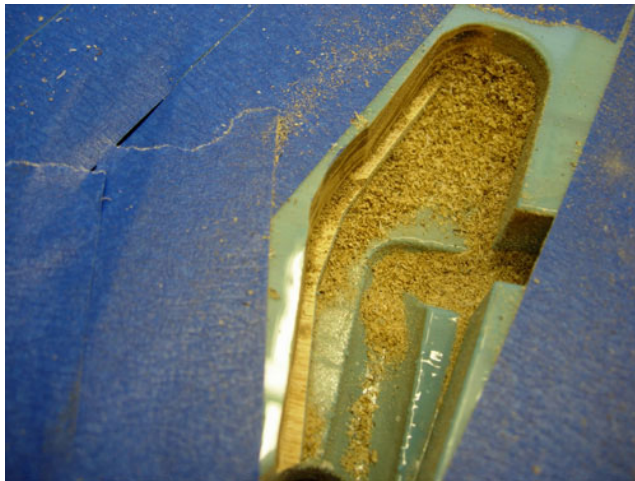

Machining completed.



## **Shielding the body**

To complete the 'Faraday Cage' effect (shielding the electrics), the body is also lined with foil. The scratch-plate acts like the lid and the overlap on the body will complete the circuit/contact with the scratch-plate foil.

Once this is in place the foil is 'earthed' and eventually soldered to the circuit (pots). A wire from the spring-claw comes through to the body and is also soldered to the 'earth'.

One issue that causes problems after applying foil is the shorting out of the normal circuitry. To prevent this, a layer of insulation is placed at the bottom and to the side of the 5 way switch (the most likely areas to be affected)



## Neck, body & scratch-plate!

I keep telling people that the geometry is inter-dependant when I am asked about set-ups. Here I have altered the edge of the neck pocket by the added lacquer thickness and the small gap/allowance that I initially had has now disappeared too. There is more tweaking the end of the neck. Sealer is applied and onwards with fitting the body, scratch-plate and neck.

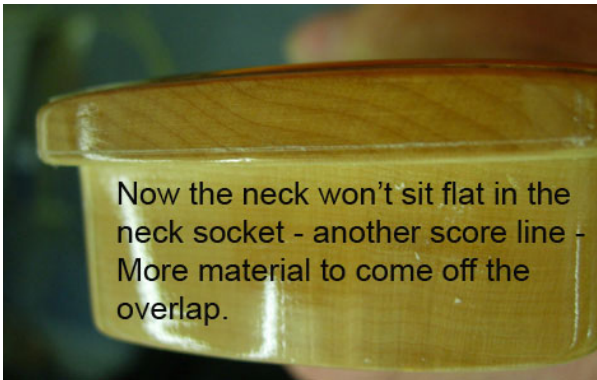

## Fitting the Tremolo Claw

Pilot holes for the tremolo claw now need to be drilled out. It's best to put the plate as low as possible. If it's too high, the back plate won't sit flat and the screws may be bent in getting it on. Once it's in place, an earth wire is soldered in place and fed through to the control cavity.

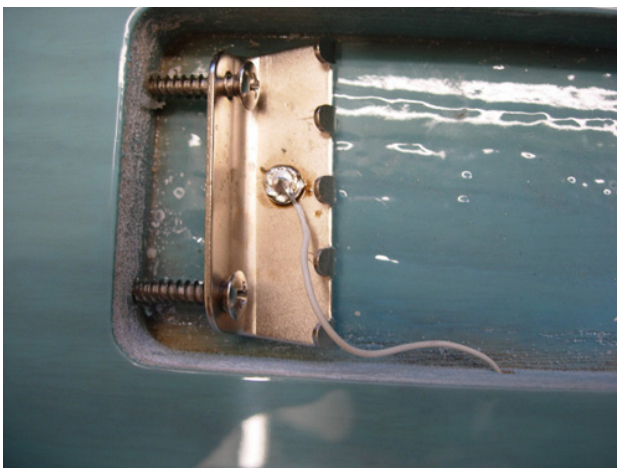
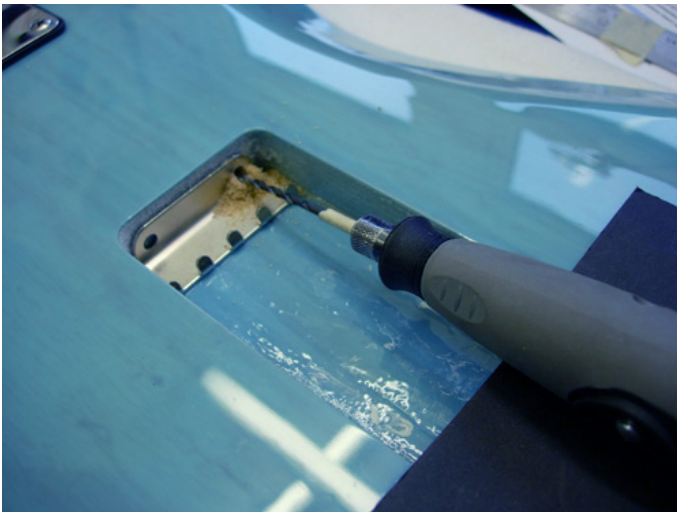



## Fitting the Strap Buttons

While we have the drill out, I fit the strap buttons and include the cut down Dremel felt wheels that are just the right size for the padding under the strap buttons - sometimes you can cut down and get 3 pads from 1 wheel.

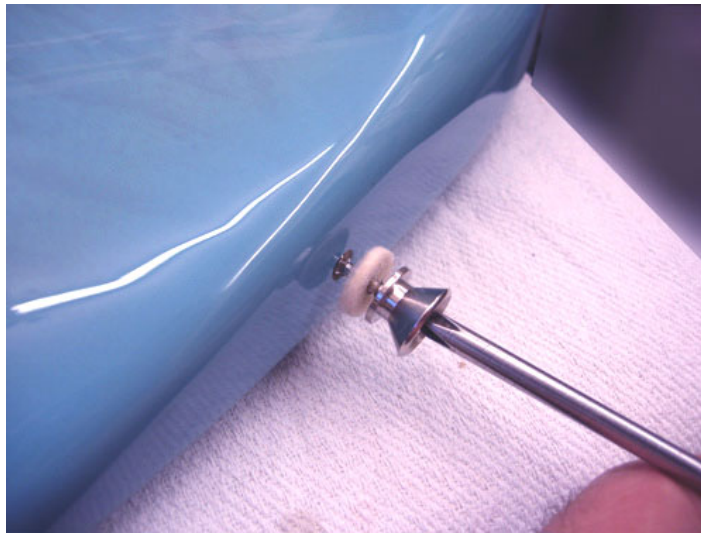

## Fitting the Tremolo

After marking out, drilling & fitting the post holes for the tremolo, the next step is to load it into the guitar. It's a little easier with the Vintage tremolo because it sits on the top to start with - contained with screws. The floating tremolo is tricky to fit as it has every chance of slipping backwards and taking chunks out of the lacquer! This is a very good reason for not taking all the strings off at once!

The safe way of loading the tremolo is by using a spacer in between the body and the back of the tremolo.





### Fitting the Tremolo part 2

**Trade trick:** Stage 1. By using a very weak tremolo spring, the tremolo can be set to balance in the 'V' of the posts. If the normal springs are applied, the tremolo stands a good chance of being dislodged from the posts and pulled backwards.

Stage 2 is to load some strings with reasonable tension and then the 1st normal springs can be fitted. Then the final 2 strings are fitted followed by the last normal spring. Stage 3. Finally the 'weak' spring can be taken off and we can start to tune to pitch just using 2 springs.

If the tremolo has to come off for fine adjustments to scratch-plate etc, the reverse procedure is applied to remove the tremolo.

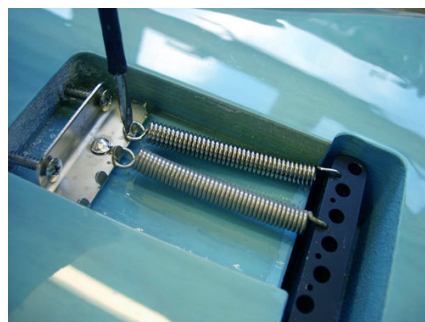
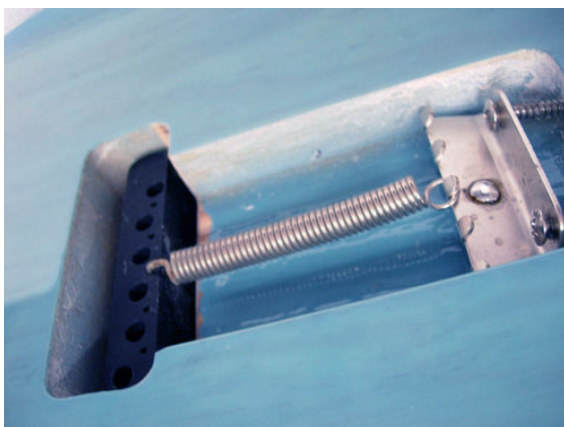

## Adjusting the Tremolo

It would be amazing if the tremolo fitted perfectly and by using a 'weak tremolo spring' the movement or lack of it can be seen and marked for adjustment. The area is protected with low tack masking tape to prevent scratches from the router. Here you can see that 2mm has been removed to give more back-pull.

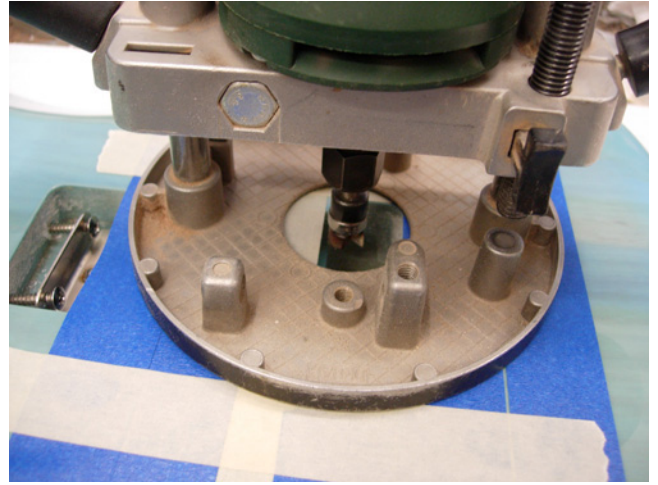
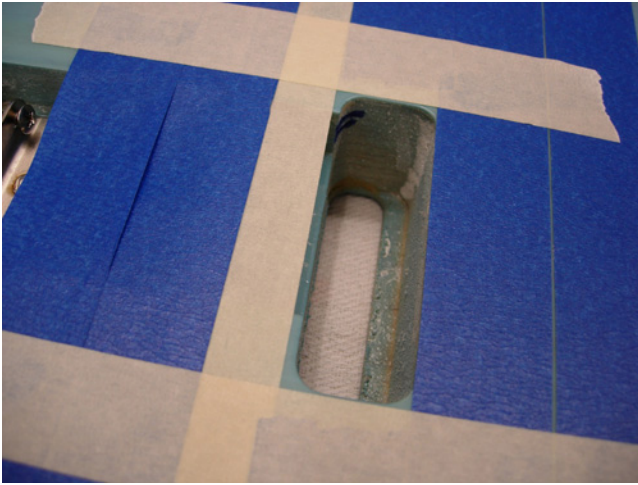

## Fitting a 'Back-stop'

With the tremolo fitted and working, one small thing that makes the trem operation feel smooth is a thin piece of rubber fitted to the inside of the trem cavity. The effect of the rubber is that of a 'bump-stop'. When the tremolo is pulled backwards, instead of a clunk being felt, the trem comes to smooth/buffered stop.

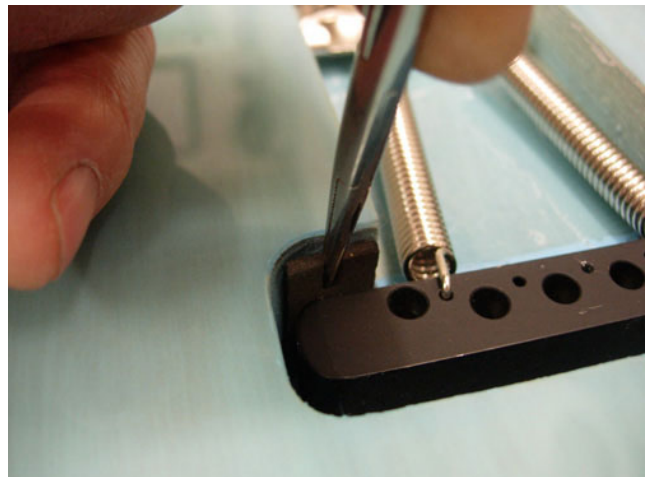

## Custom Wiring

A small custom modification to the Stratocaster's wiring can give lots of variety. The first is to make the tone control affect the bridge pickup as well as the normal middle. Too many people condemn the bridge pickup as 'harsh sounding' because they can't roll off the treble with a tone control. The second mod is the Push/Push switch - which is disguised as a Tone control (dual function). The Push/Push switch is used because the Push/Pull switch makes it difficult to operate because of the shape of the knob. The witch's hat style prevents good grip when sweaty to pull on the knob and it's much easier to press.

There are now 2 extra sounds.

- This switch connects the bridge and neck pickups together so that a new sound is achieved.
- When the 'in-between' sound is selected, ALL 3 pickups are on! - so 2 extra sounds.

The wiring for the switch is seen below and is just 2 wires linked to the 5 way switch and operated by the switch which

'piggy-backs' the tone control.

The mod to the bridge pickup is a simple link wire on the other side of the switch, joining the tone on the middle to the vacant bridge terminal.

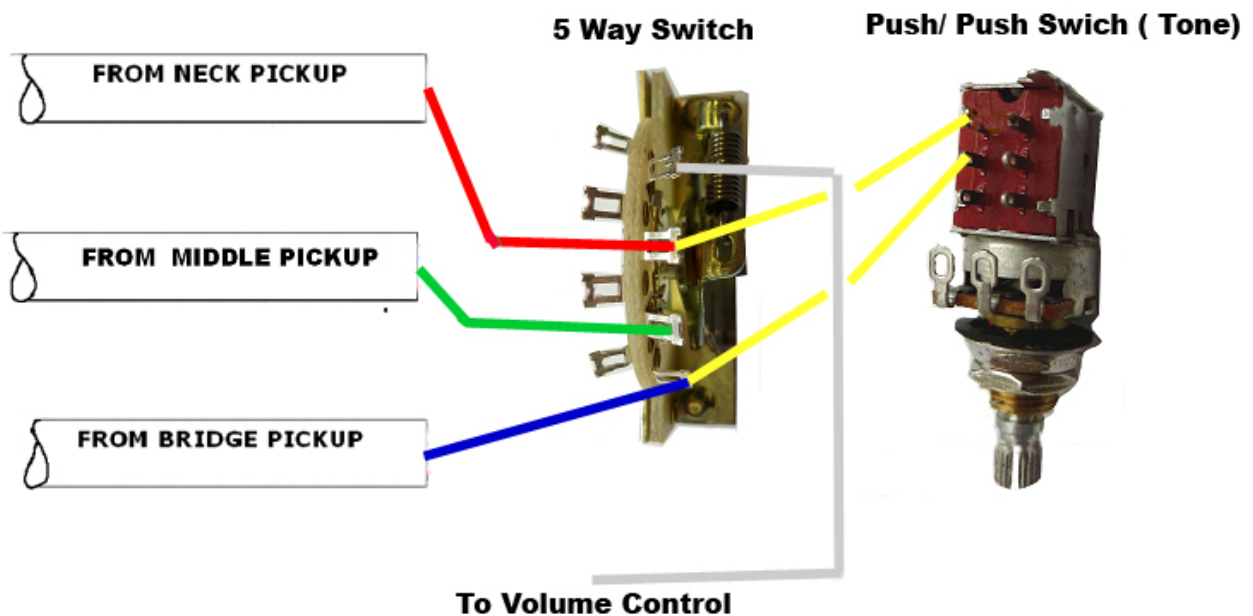
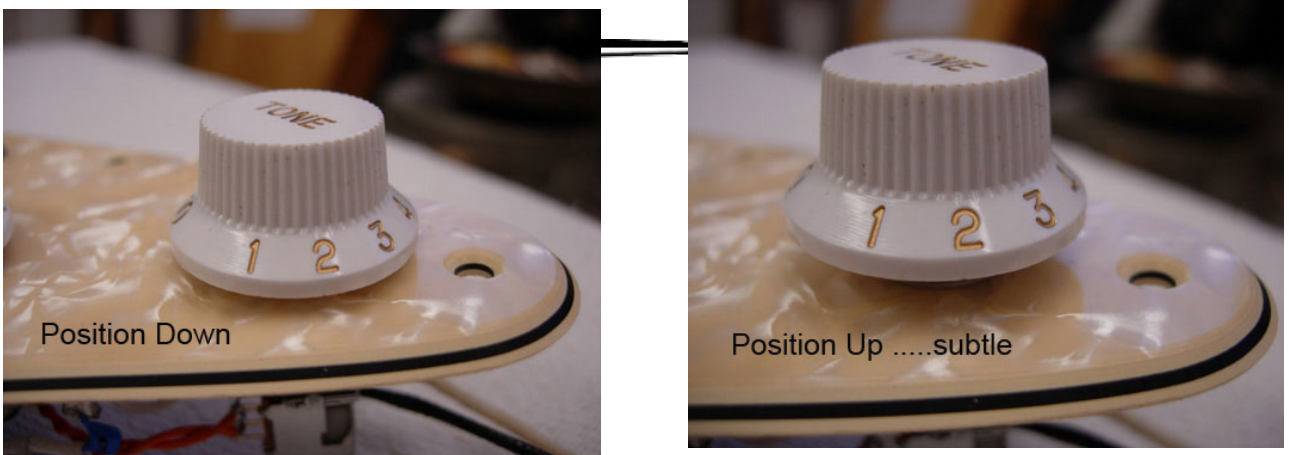

SWITCH No.	1	2	3	4	5
P/P Down	Neck	Neck & Middle	Middle	Middle & Bridge	Bridge
P/P UP	Neck & Bridge	Neck & Middle & Bridge	Middle (no change)	Neck & Middle & Bridge	Neck & Bridge

Normal Stratocaster Sounds

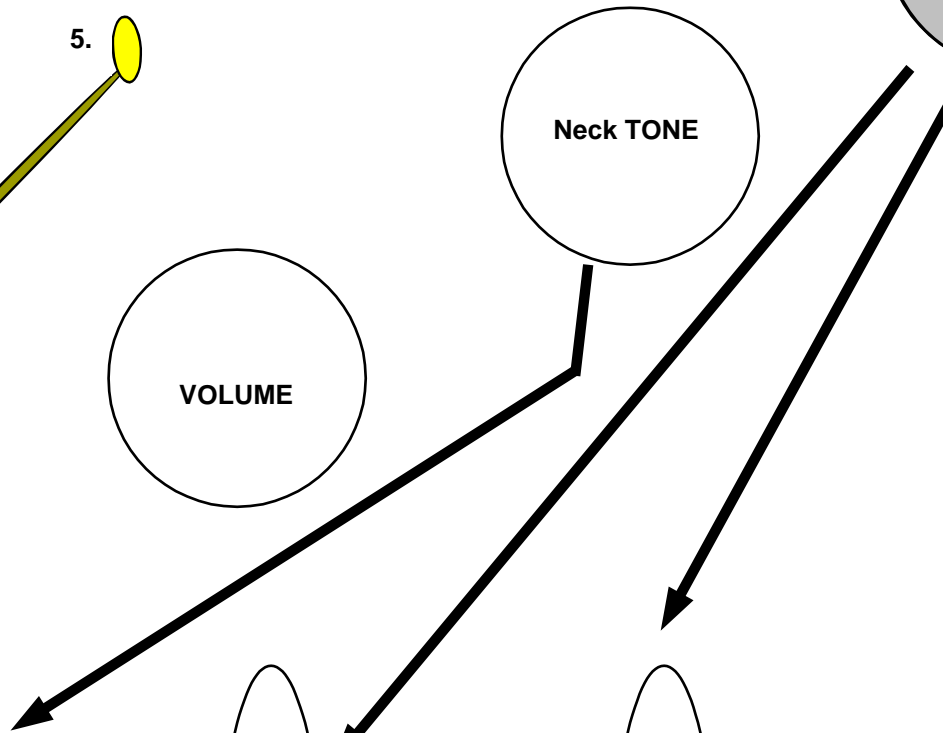
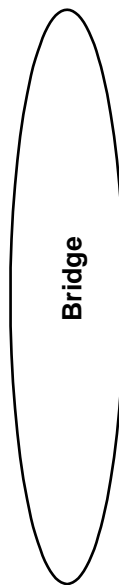
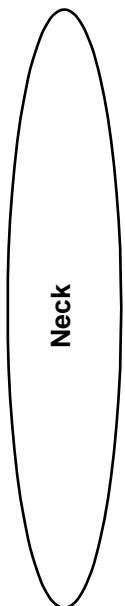
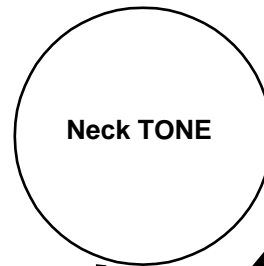
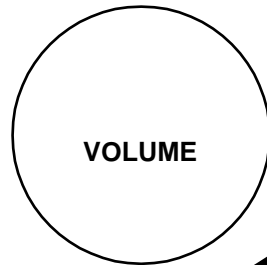
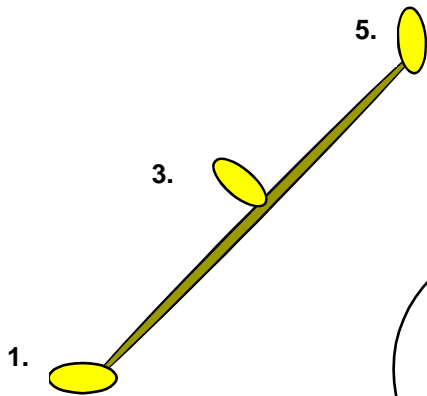
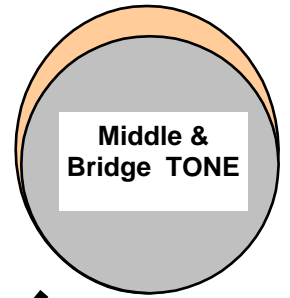
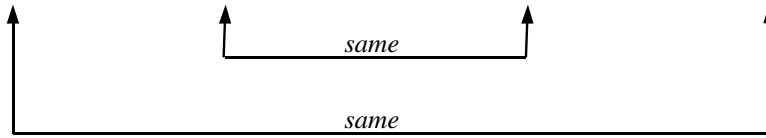

## Align the strings to the pickups

One thing that is regularly cocked-up on budget guitars is the alignment of the strings with the pickup poles neck and bridge. Ideally, if the neck is close to being central with the body, the scratch-plate & pickups will be in the right place. If it's not, the edge of the scratch-plate may have to be re-shaped to look right. Here we have 1mm either side and it's in the right place. Drilling the holes for the scratch-plate - yes I said drilling pilot holes - it will allow for an easy fit. If you're doing this on maple you definitely need pilot holes as it's a hard wood. I prefer to use only 2 screw locations to start with - one at the neck and one at the tremolo. After the holes are countersunk and a test fit shows if it's correct, the rest of the holes can be drilled. Remembering the carpenter's saying of 'measure twice, cut once'! The niggle with the extra fret neck (22 frets) is that the lip over the body makes me have to go through the procedure of unloading the tremolo to partially remove the neck to allow the scratch-plate to be removed - that same lip that caused trouble earlier on. Finally all the holes can be marked, drilled and then countersunk to prevent chipping or delaminating the paint and lacquer.

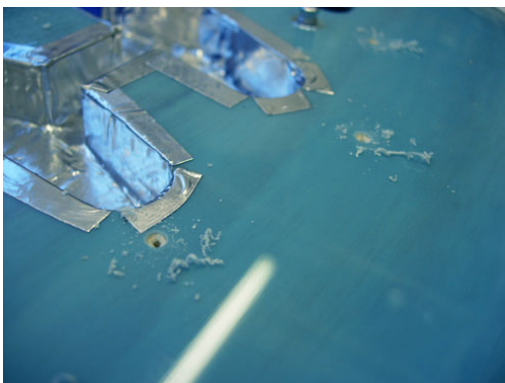

### Alignment to the tremolo

That 1mm adjustment has made the tremolo look lopsided in relation to the scratch-plate so a small adjustment by marking out with tape and a tweak off the guitar makes the picture look balanced.



### Wiring in the Jack socket

The scratch-plate can now be fitted and the trem earth wire, shield wires soldered. In addition the earth and live can be threaded through to the jack socket and then the socket plate can be fitted. Positioning the socket plate is important because the jack needs to have enough room at the end of the jack socket, so it's off-set toward the bottom. If you didn't, an additional amount would have to be carved out of the cavity. The edge can be viewed from the top hole and the bottom hole is drilled off centre to allow movement away from the upper edge of the hole. It's drilled, countersunk and, after a quick soldering operation, the scratch-plate can now be finally fitted.

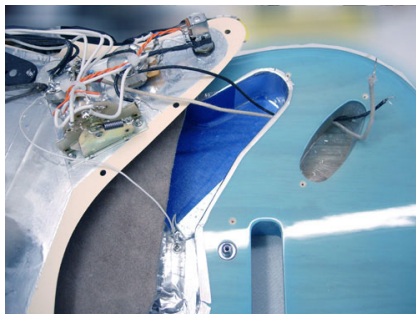

## Fitting the string trees

The 2 string trees are fitted using the same technique of drilling and countersinking holes.

Their heights are set similar to that of the 5th string angle from the nut.



**Next Step**..... The final part of the 'Project' is the set-up

Tuned to pitch and setting the relief.

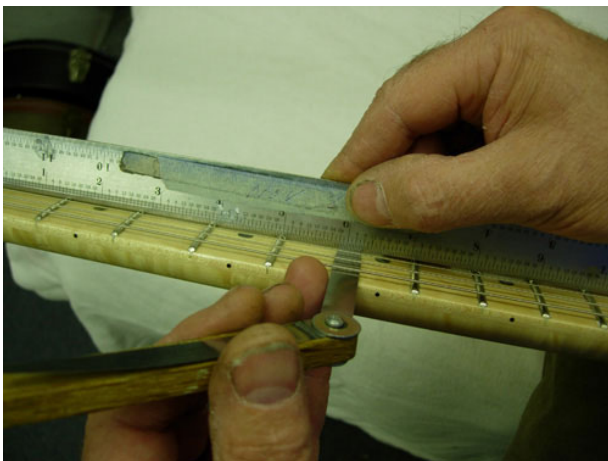

Cutting the nut slots to the correct depth.



Setting the tremolo - slight forward tilt.

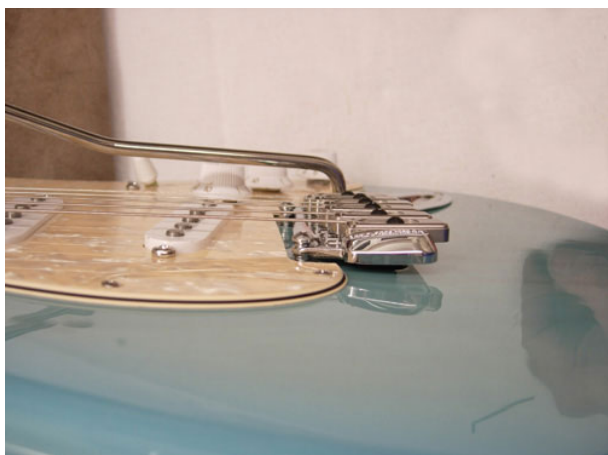

Setting the treble height of the 1st String.





Setting the bass height 6th string.



Adjusting the saddles heights.



Adjust the intonation & height check.



Locking down all the saddles.



Finally, the pickup heights can be set. This is done by fretting on the last fret and measuring from the pole piece to the underneath of the string. **Note:** Staggered pole pieces are set further away than the even/flat pole pieces.

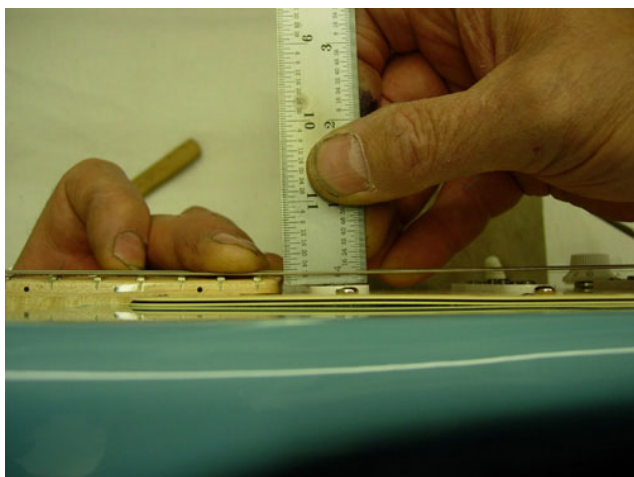

### **Fitting the back-plate.**

The back-plate needs to be positioned so that the slot in it lines up with the strings so that they can be threaded through it.

Masking tape allows pencil marks to be drawn and to check that there is actually wood to screw into! Some slots in the back-plate line up but the screw holes can be in thin air!

Before marking out, it's important that the tremolo doesn't move. As soon as you turn it over, the weight of the guitar moves the tremolo. To get round this, the body is put on 2 padded blocks so it doesn't move. Now the back-plate can be marked out, drilled, counter-sunk and screwed down.

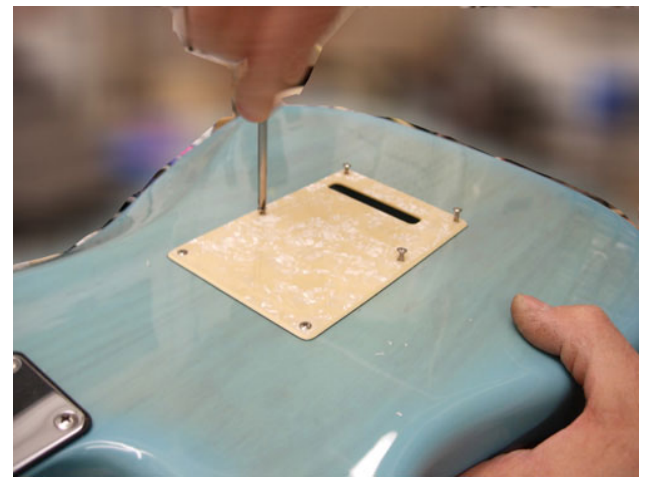
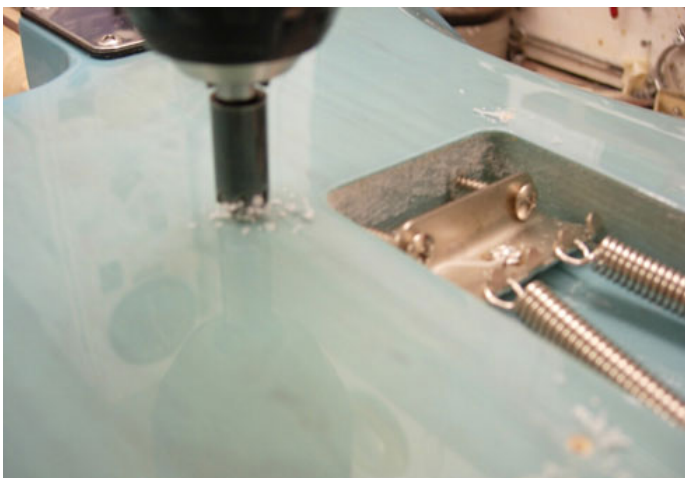
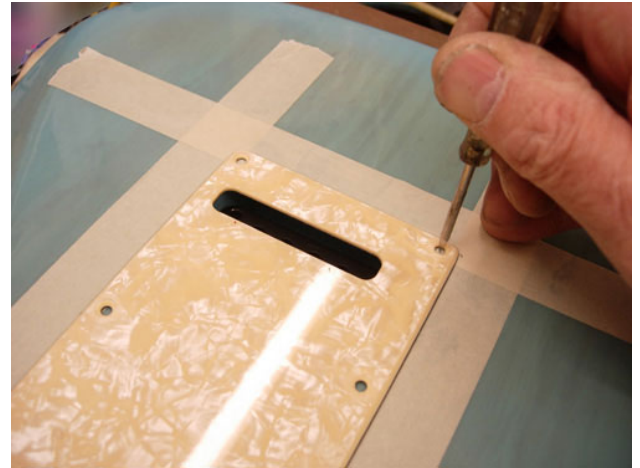

**BELOW**

### **Some pictures of the completed guitar!**

The last operation is to give the guitar a final polish and the Invoice can be itemised and put with the guitar. The Hiscox case is the best protection the guitar can have - nice choice!





Project completed 26<sup>th</sup> June 2014

*Peter Allen*  
Custom 